

個人対抗戦タイムテーブル(男子)

5月22日(水) 男子 ダブルス・シングルス カメイアリーナ仙台

	1	2	3	4	5	6	7	8	9	10	11	12	13	14	15	16	17	18
9:00	BD1	BD2	BD3	BD4	BD5	BD6	BD7	BD8	BD9	BD10	BD11	BD12	BD13	BD14	BD82	BD83	BD84	BD85
	BD15	BD16	BD17	BD18	BD19	BD20	BD21	BD22	BD23	BD24	BD25	BD26	BD27	BD28	BD86	BD87	BD88	BD89
	BD29	BD30	BD31	BD32	BD33	BD34	BD35	BD36	BD37	BD38	BD39	BD40	BD41	BD42	BD90	BD91	BD92	BD93
10:00	BD43	BD44	BD45	BD46	BD47	BD48	BD49	BD50	BD51	BD52	BD53	BD54	BD55	BD56	BD94	BD95	BD96	BD97
	BD57	BD58	BD59	BD60	BD61	BD62	BD63	BD64	BD65	BD66	BD67	BD68	BD69	BD70	BD98	BD99	BD100	BD101
	BD71	BD72	BD73	BD74	BD75	BD76	BD77	BD78	BD79	BD80	BD81		BD105	BD106	BD102	BD103	BD104	
	BD107	BD108	BD109	BD110	BD111	BD112	BD113	BD114	BD115	BD116	BD117	BD118	BD119	BD120	BD155	BD156	BD157	BD158
11:00	BD121	BD122	BD123	BD124	BD125	BD126	BD127	BD128	BD129	BD130	BD131	BD132	BD133	BD134	BD159	BD160	BD161	BD162
	BD135	BD136	BD137	BD138	BD139	BD140	BD141	BD142	BD143	BD144	BD145	BD146	BD147	BD148	BD163	BD164	BD165	BD166
	BD149	BD150	BD151	BD152	BD153	BD154		BD169	BD170	BD171	BD172	BD173	BD174	BD175	BD167	BD168		BD194
12:00	BD176	BD177	BD178	BD179	BD180	BD181	BD182	BD183	BD184	BD185	BD186	BD187	BD188	BD189	BD195	BD196	BD197	BD198
	BD190	BD191	BD192	BD193											BD199	BD200		BS92
	BD201	BD202	BD203	BD204	BD205	BD206	BD207	BD208	BD209	BD210	BD211	BD212	BD213	BD214	BS93	BS94	BS95	BS96
13:00	BD215	BD216		BS1	BS2	BS3	BS4	BS5	BS6	BS7	BS8	BS9	BS10	BS11	BS97	BS98	BS99	BS100
	BS12	BS13	BS14	BS15	BS16	BS17	BS18	BS19	BS20	BS21	BS22	BS23	BS24	BS25	BS101	BS102	BS103	BS104
	BD217	BD218	BD219	BD220	BD221	BD222	BD223	BD224		BS26	BS27	BS28	BS29	BS30	BS105	BS106	BS107	BS108
14:00	BS31	BS32	BS33	BS34	BS35	BS36	BS37	BS38	BS39	BS40	BS41	BS42	BS43	BS44	BS109	BS110	BS111	BS112
	BD225	BD226	BD227	BD228		BS45	BS46	BS47	BS48	BS49	BS50	BS51	BS52	BS53	BS113	BS114	BS115	BS116
	BS54	BS55	BS56	BS57	BS58	BS59	BS60	BS61	BS62	BS63	BS64	BS65	BS66	BS67	BS117	BS118	BS119	BS120
15:00	BD229	BD230		BS68	BS69	BS70	BS71	BS72	BS73	BS74	BS75	BS76	BS77	BS78	BS121		BS170	BS171
	BS79	BS80	BS81	BS82	BS83	BS84	BS85	BS86	BS87	BS88	BS89	BS90	BS91		BS172	BS173	BS174	BS175
	BD231	BD232		BS122	BS123	BS124	BS125	BS126	BS127	BS128	BS129	BS130	BS131	BS132	BS176	BS177	BS178	BS179
16:00	BS133	BS134	BS135	BS136	BS137	BS138	BS139	BS140	BS141	BS142	BS143	BS144	BS145	BS146	BS180	BS181	BS182	BS183
	BS147	BS148	BS149	BS150	BS151	BS152	BS153	BS154	BS155	BS156	BS157	BS158	BS159	BS160	BS184	BS185		
	BS161	BS162	BS163	BS164	BS165	BS166	BS167	BS168	BS169									

5月23日(木) 男子シングルス カメイアリーナ仙台

	1	2	3	4	5	6	7	8	9	10	11	12	13	14
8:30	学校対抗戦組み合わせ													
9:00	BS186	BS187	BS188	BS189	BS190	BS191	BS192	BS193	BS194	BS195	BS196	BS197	BS198	BS199
	BS200	BS201	BS202	BS203	BS204	BS205	BS206	BS207	BS208	BS209	BS210	BS211	BS212	BS213
	BS214	BS215	BS216	BS217										
10:00	BS218	BS219	BS220	BS221	BS222	BS223	BS224	BS225	BS226	BS227	BS228	BS229	BS230	BS231
	BS232	BS233												
11:00	BS234	BS235	BS236	BS237	BS238	BS239	BS240	BS241						
12:00	BS242	BS243	BS244	BS245										
13:00	BS246	BS247												
14:00	BS248	BS249												

BD BS の試合は21ポイントマッチ

(男子) 会場 カメイアリーナ仙台

日・時間	1	2	3	4	5	6	7	8	9	10	11	12	13	14	15	16	17	18
5/22 (水) 前半	仙台一	仙台二	仙台三	宮城一	仙台三樓	仙台向山	仙台西	仙台東	宮城広瀬	泉	泉松陵	富谷	仙台工	仙台商	塩釜	多賀城	高専広瀬	東北学院
5/22 (水) 後半	仙台育英	仙台大明成	東北	泉館山	学院櫛ヶ岡	東北生文大	仙台城南	宮城工	仙台	松島	聖和	尚綱	黒川	石巻工	古川	古川黎明	名取	築館
5/23 (木) 前半	迫桜	仙台大明成	角田	登米総合	登米	佐沼	塩釜	仙台	仙台一	東北生文大	聖和	東北学院	東北	名取北				
5/23 (木) 後半	仙台三	仙台西	仙台東	多賀城	泉松陵	松島	仙台工	宮城工										

上級生が主審、線審を行ってください。

個人対抗戦タイムテーブル(女子)

5月24日(金) 女子 ダブルス・シングルス カメイアリーナ仙台

	1	2	3	4	5	6	7	8	9	10	11	12	13	14	15	16	17	18
9:00	GD1	GD2	GD3	GD4	GD5	GD6	GD7	GD8	GD9	GD10	GD11	GD12	GD13	GD14	GD15	GD16	GD17	GD18
	GD15	GD16	GD17	GD18	GD19	GD20	GD21	GD22	GD23	GD24	GD25	GD26	GD27	GD28	GD29	GD30	GD31	GD32
	GD29	GD30	GD31	GD32	GD33	GD34	GD35	GD36	GD37	GD38	GD39	GD40	GD41	GD42	GD43	GD44	GD45	GD46
10:00	GD43	GD44	GD45	GD46	GD47	GD48	GD49	GD50	GD51	GD52	GD53	GD54	GD55	GD56	GD57	GD58	GD59	GD60
	GD57	GD58	GD59	GD60	GD61	GD62	GD63	GD64	GD65	GD66	GD67	GD68	GD69	GD70	GD71	GD72	GD73	GD74
	GD71	GD72		GD93	GD94	GD95	GD96	GD97	GD98	GD99	GD100	GD101	GD102	GD103		GD143	GD144	GD145
11:00	GD104	GD105	GD106	GD107	GD108	GD109	GD110	GD111	GD112	GD113	GD114	GD115	GD116	GD117	GD118	GD119	GD120	GD121
	GD118	GD119	GD120	GD121	GD122	GD123	GD124	GD125	GD126	GD127	GD128	GD129	GD130	GD131	GD132	GD133	GD134	GD135
	GD132	GD133	GD134	GD135	GD136	GD137	GD138	GD139	GD140	GD141	GD142		GD157	GD158	GD159	GD160	GD161	GD162
12:00	GD159	GD160	GD161	GD162	GD163	GD164	GD165	GD166	GD167	GD168	GD169	GD170	GD171	GD172	GD173	GD174	GD175	GD176
	GD173	GD174	GD175	GD176	GD177	GD178	GD179	GD180	GD181						GD186	GD187	GD188	
	GD189	GD190	GD191	GD192	GD193	GD194	GD195	GD196	GD197	GD198	GD199	GD200	GD201	GD202	GS92	GS93	GS94	GS95
13:00	GD203	GD204		GS1	GS2	GS3	GS4	GS5	GS6	GS7	GS8	GS9	GS10	GS11	GS12	GS13	GS14	GS15
	GS12	GS13	GS14	GS15	GS16	GS17	GS18	GS19	GS20	GS21	GS22	GS23	GS24	GS25	GS100	GS101	GS102	GS103
	GD205	GD206	GD207	GD208	GD209	GD210	GD211	GD212		GS26	GS27	GS28	GS29	GS30	GS104	GS105	GS106	GS107
14:00	GS31	GS32	GS33	GS34	GS35	GS36	GS37	GS38	GS39	GS40	GS41	GS42	GS43	GS44	GS108	GS109	GS110	GS111
	GD213	GD214	GD215	GD216		GS45	GS46	GS47	GS48	GS49	GS50	GS51	GS52	GS53	GS112	GS113	GS114	GS115
	GS54	GS55	GS56	GS57	GS58	GS59	GS60	GS61	GS62	GS63	GS64	GS65	GS66	GS67	GS116	GS117	GS118	GS119
15:00	GD217	GD218		GS68	GS69	GS70	GS71	GS72	GS73	GS74	GS75	GS76	GS77	GS78	GS120		GS169	GS170
	GS79	GS80	GS81	GS82	GS83	GS84	GS85	GS86	GS87	GS88	GS89	GS90	GS91		GS171	GS172	GS173	GS174
	GD219	GD220		GS121	GS122	GS123	GS124	GS125	GS126	GS127	GS128	GS129	GS130	GS131	GS132	GS133	GS134	GS135
16:00	GS132	GS133	GS134	GS135	GS136	GS137	GS138	GS139	GS140	GS141	GS142	GS143	GS144	GS145	GS175	GS176	GS177	GS178
	GS146	GS147	GS148	GS149	GS150	GS151	GS152	GS153	GS154	GS155	GS156	GS157	GS158	GS159	GS183	GS184		
	GS160	GS161	GS162	GS163	GS164	GS165	GS166	GS167	GS168									

5月25日(土) 女子シングルス カメイアリーナ仙台

	1	2	3	4	5	6	7	8	9	10	11	12	13	14
8:30	学校対抗戦組み合わせ													
9:00	GS185	GS186	GS187	GS188	GS189	GS190	GS191	GS192	GS193	GS194	GS195	GS196	GS197	GS198
	GS199	GS200	GS201	GS202	GS203	GS204	GS205	GS206	GS207	GS208	GS209	GS210	GS211	GS212
	GS213	GS214	GS215	GS216										
10:00	GS217	GS218	GS219	GS220	GS221	GS222	GS223	GS224	GS225	GS226	GS227	GS228	GS229	GS230
	GS231	GS232												
11:00	GS233	GS234	GS235	GS236	GS237	GS238	GS239	GS240						
12:00	GS241	GS242	GS243	GS244										
13:00	GS245	GS246												
14:00	GS247	GS248												

GD GS の試合は21ポイントマッチ

(女子) 会場 カメイアリーナ仙台

日・時間	1	2	3	4	5	6	7	8	9	10	11	12	13	14	15	16	17	18	
5/24(金)前半	石巻桜坂	築佐館沼	富谷	登米登米総合	気仙沼向洋	気仙沼	泉	大河原	宮城農	白石	古川学園	宮城学院	宮城広瀬	常盤木	ウルスラ	黒古川	古川黎明	岩中新山	一迫桜
5/24(金)後半	ドミニコ	仙台育英	富谷	泉館山	仙台二華	仙台三桜	仙台西	名取北	塩釜	仙台商	仙台一	仙台三	角田	仙台城南	仙台東	泉松陵	松島	多賀城	
5/25(土)前半	仙台一	泉	仙台二	泉館山	仙台二華	仙台三桜	仙台西	名取北	名取	宮城学院	仙台大成	宮城一	仙台青陵	東北					
5/25(土)後半	仙台一	仙台向山	仙台二	仙台青陵	東北生文大	仙台商	聖和	尚綱											

上級生が主審、線審を行ってください。

令和6年度 第73回高等学校総合体育大会バドミントン競技 個人対抗戦
 高校男子ダブルス (BD232)

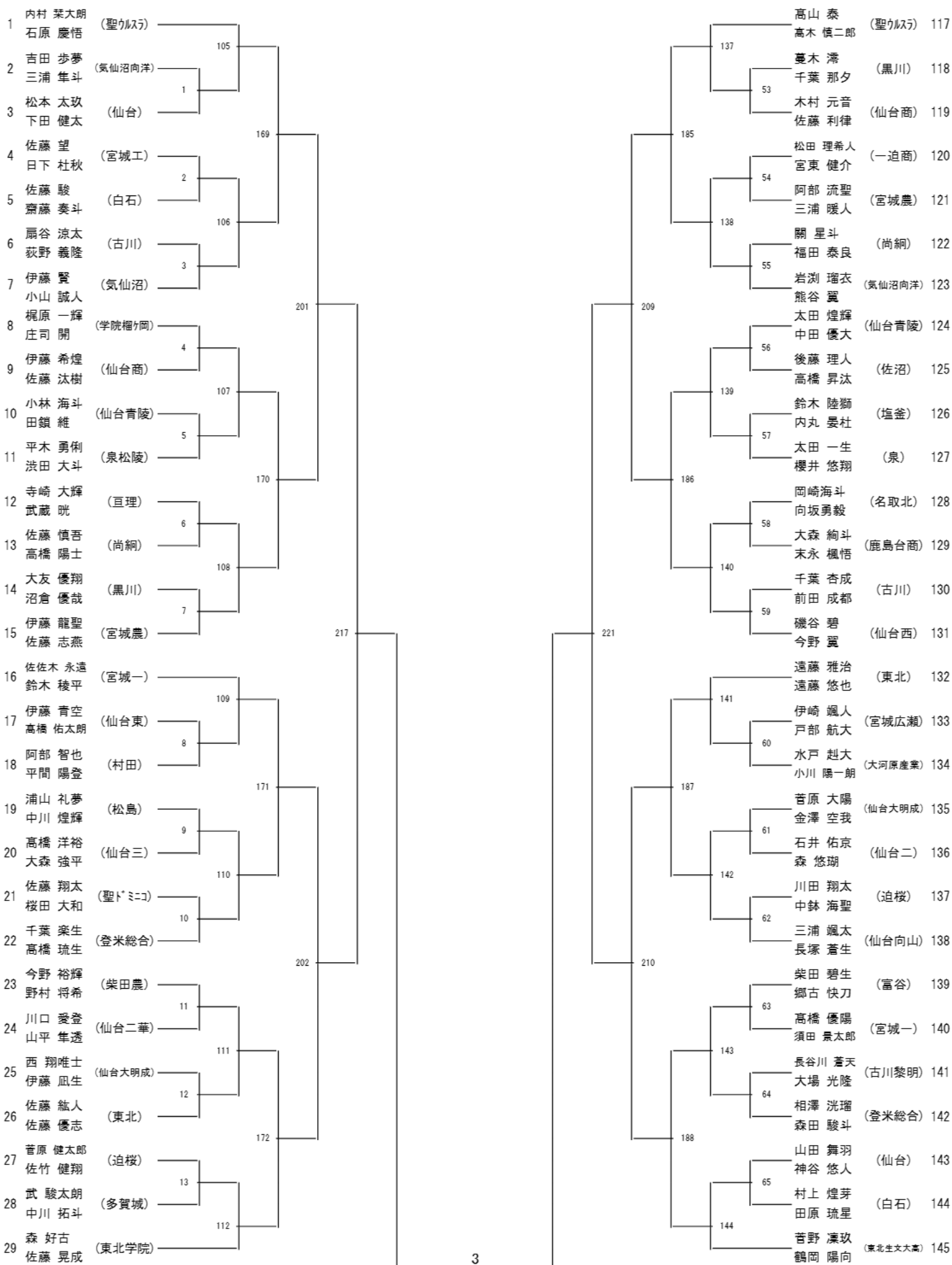

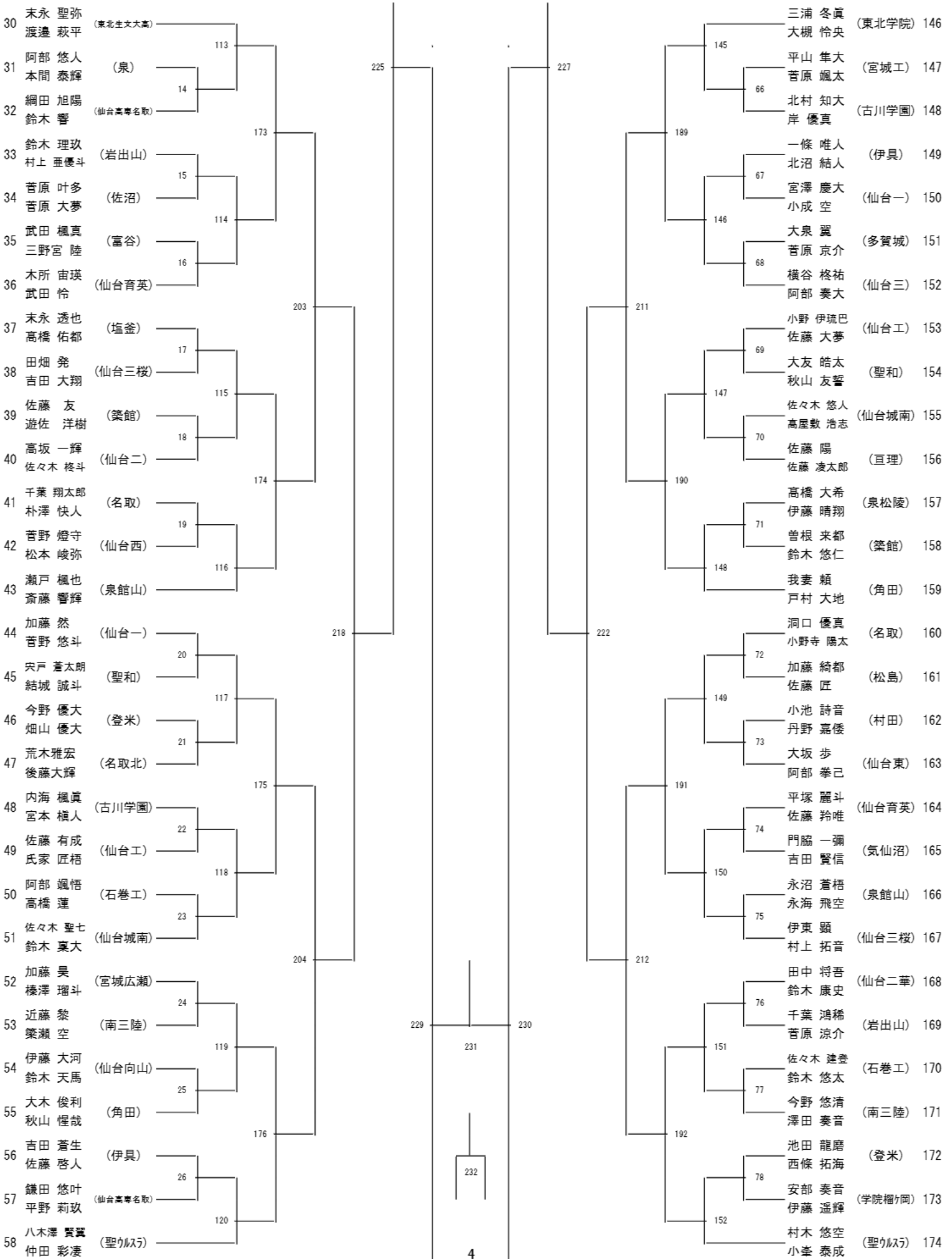

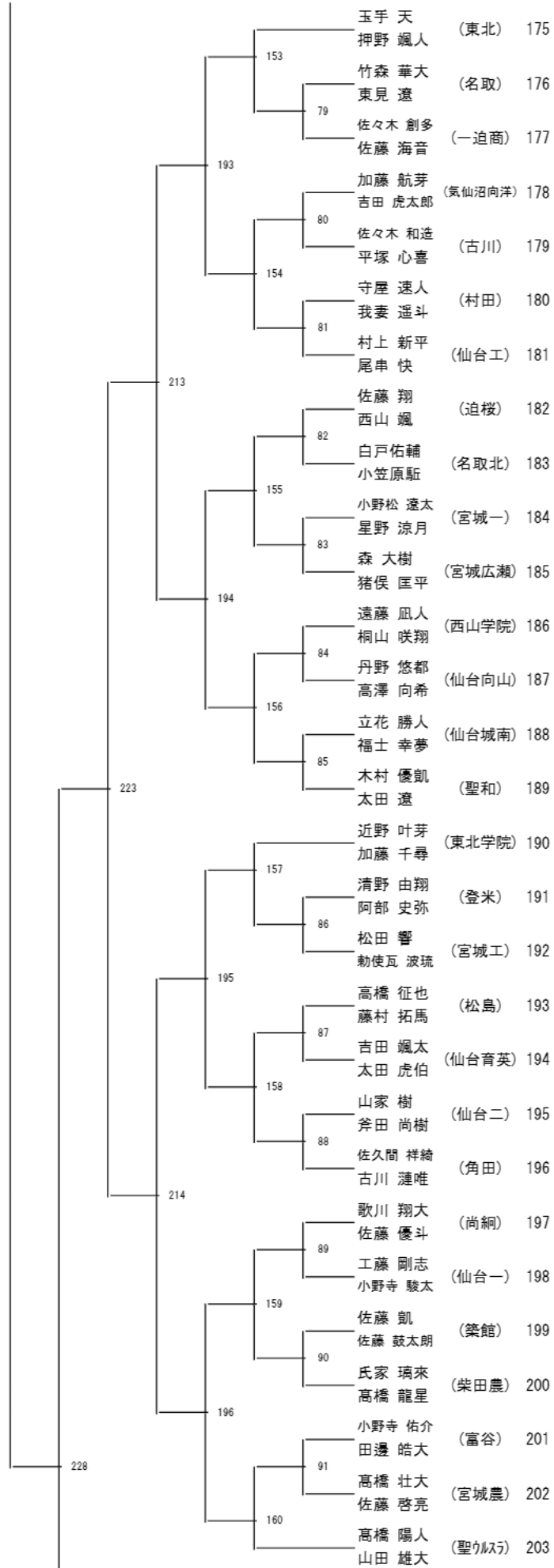
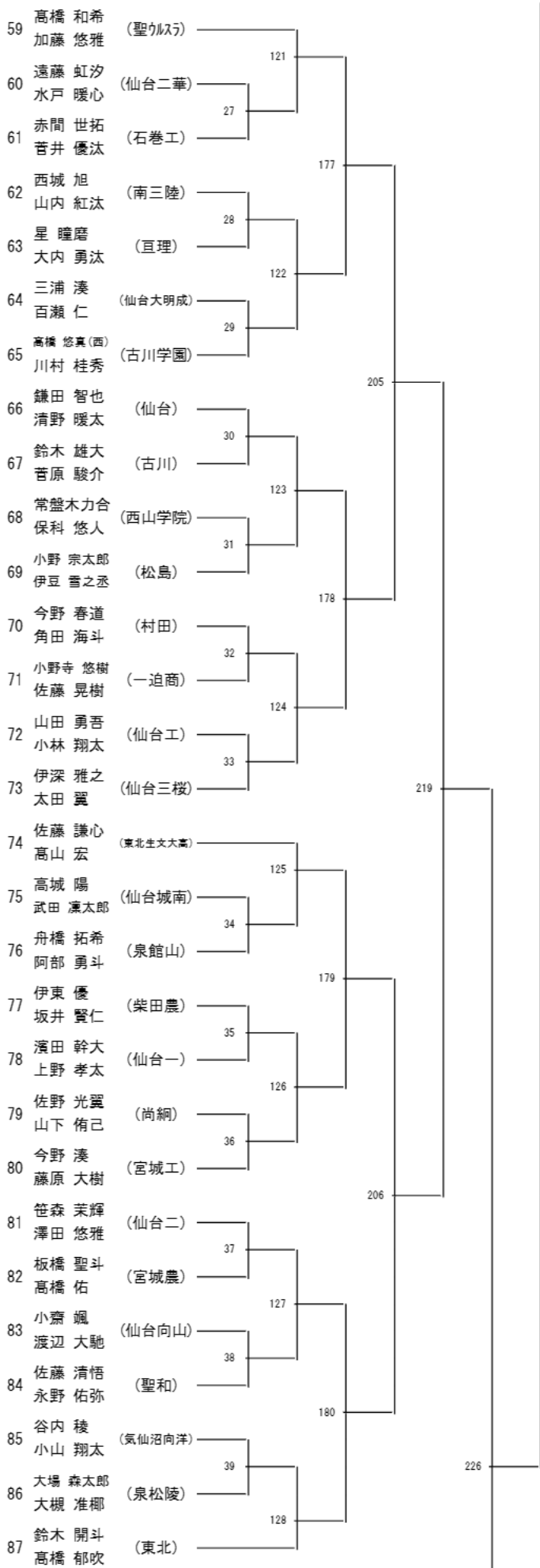

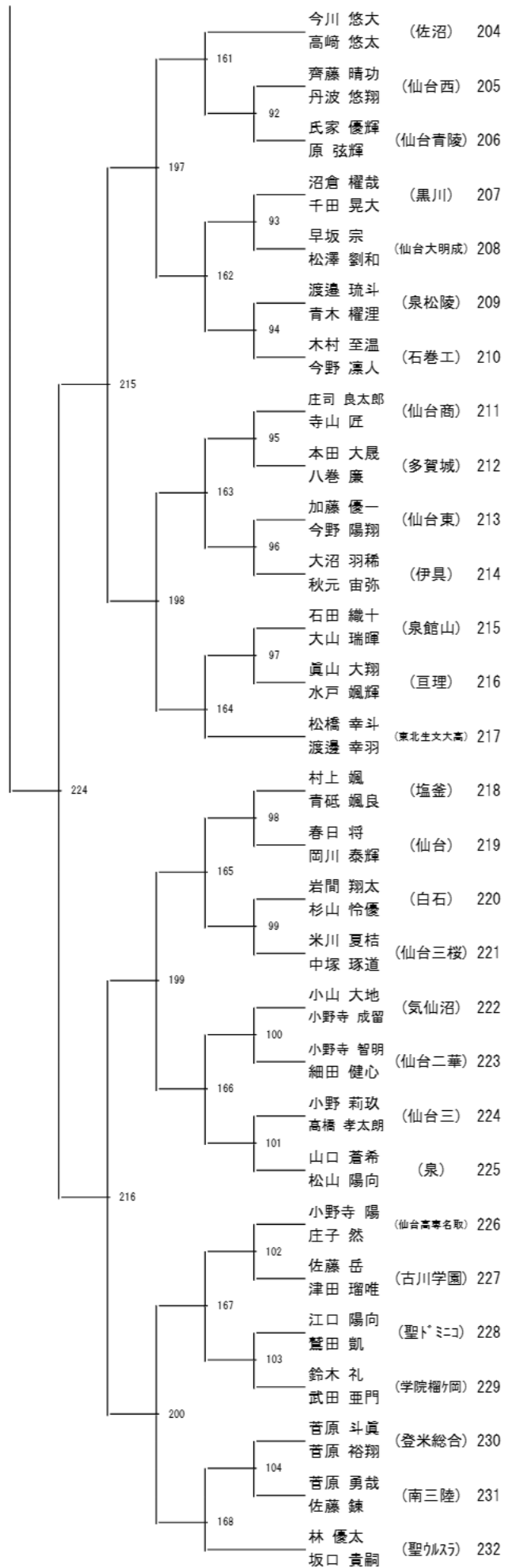
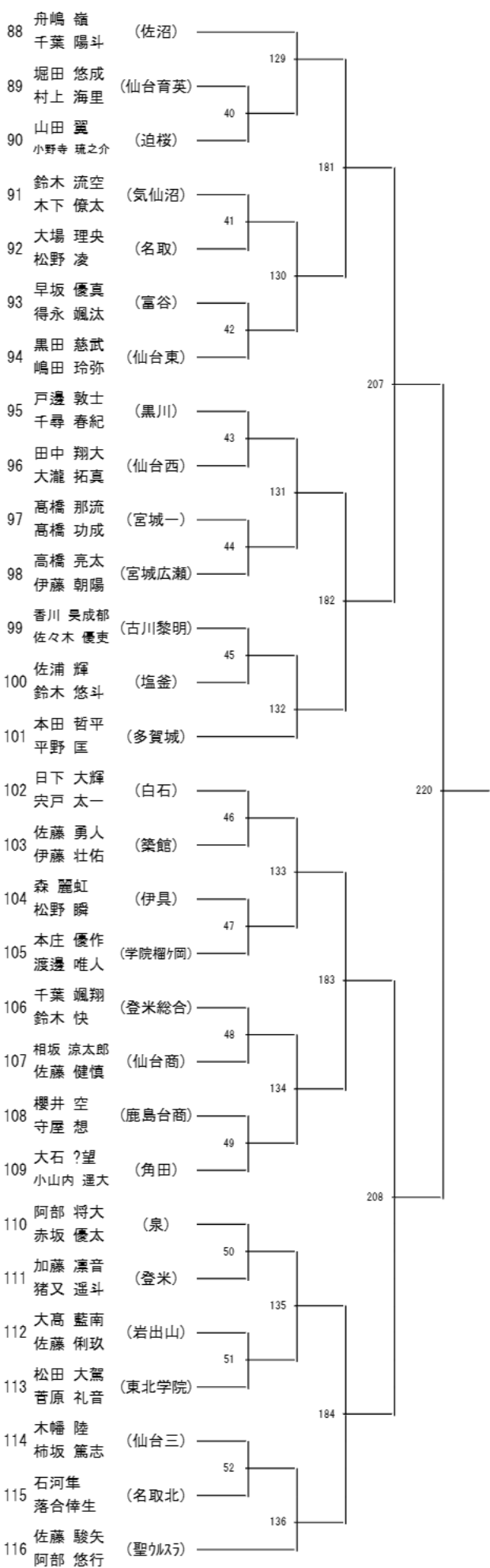

令和6年度 第73回高等学校総合体育大会バドミントン競技 個人対抗戦
 高校男子シングルス(BS249)

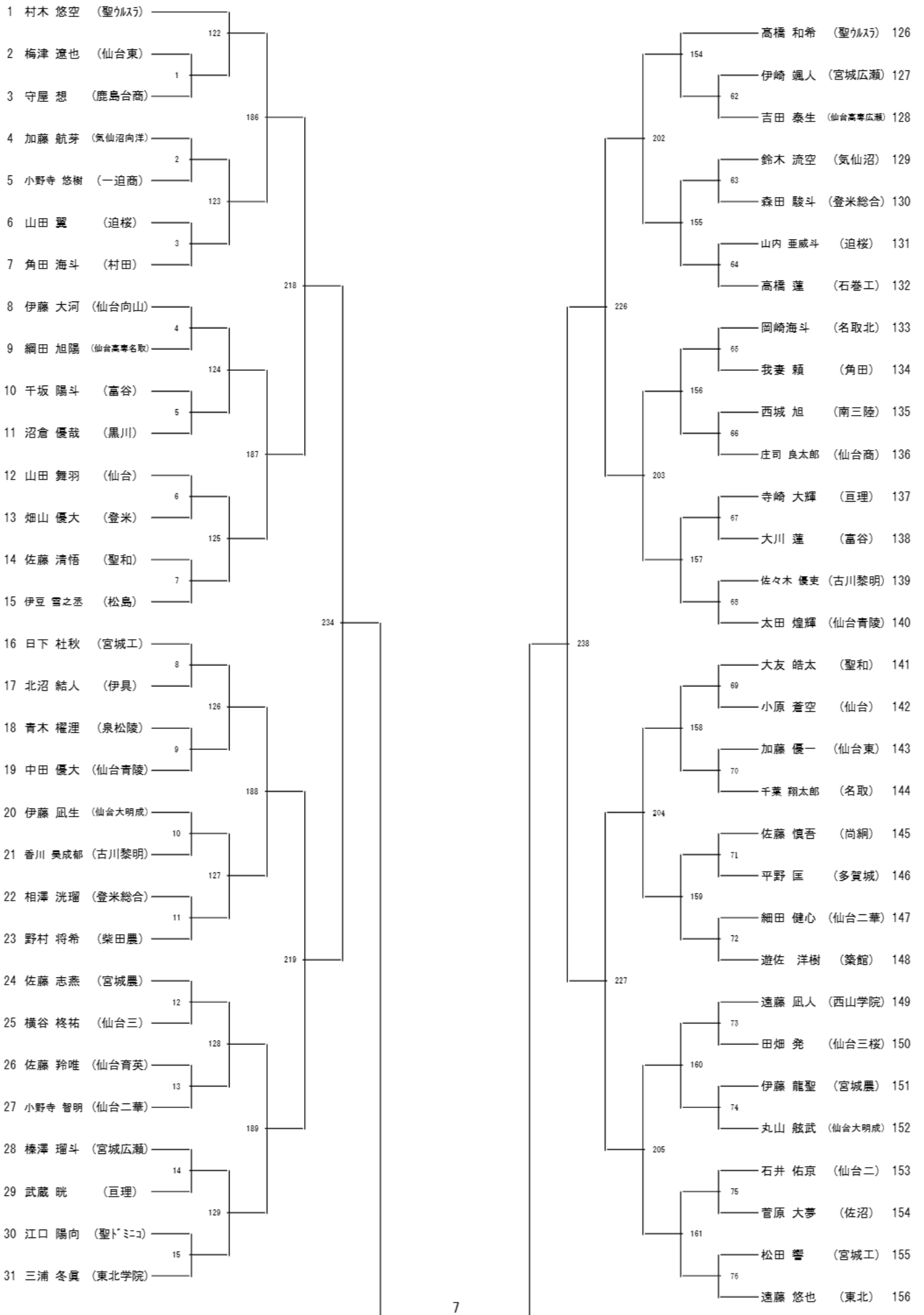

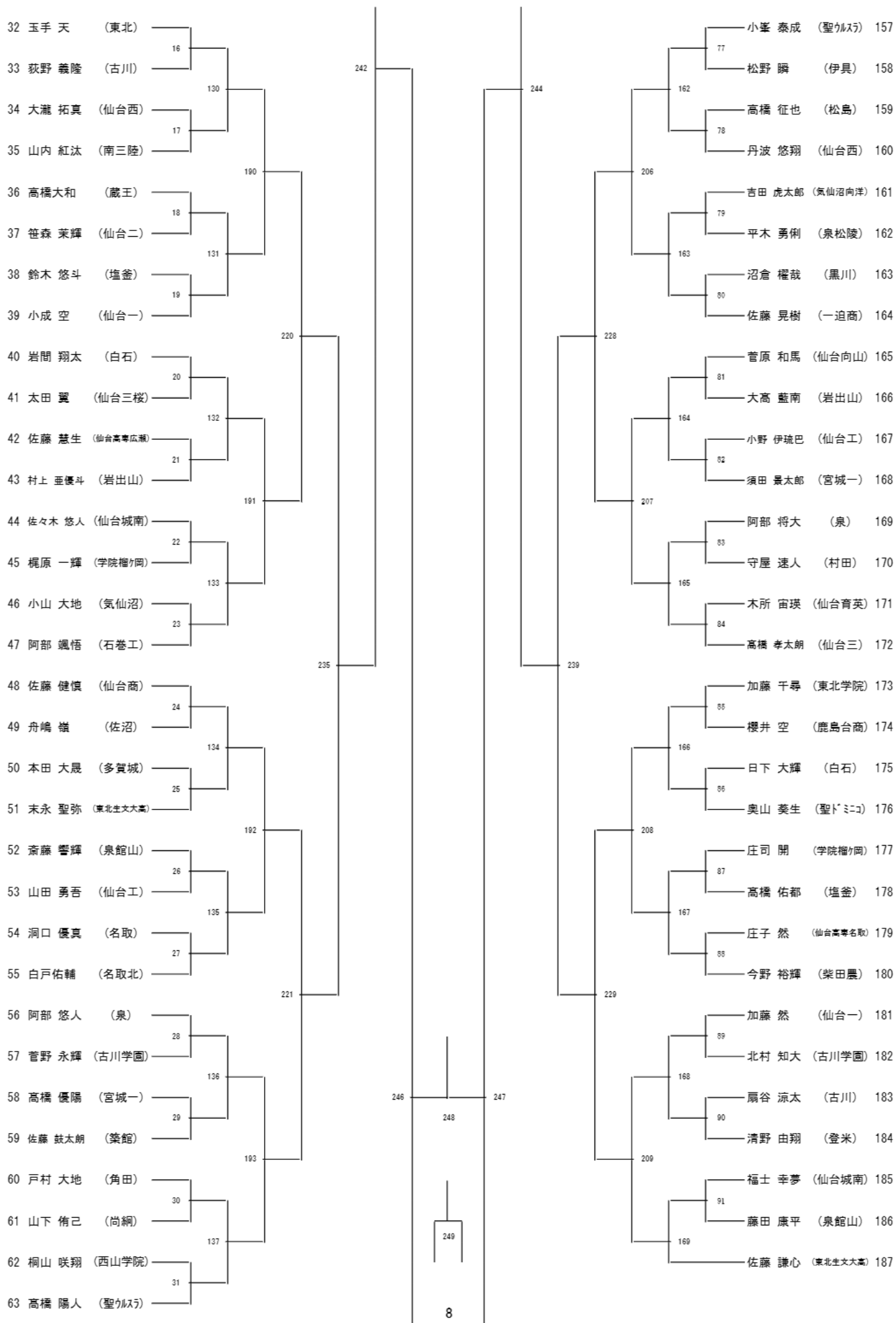

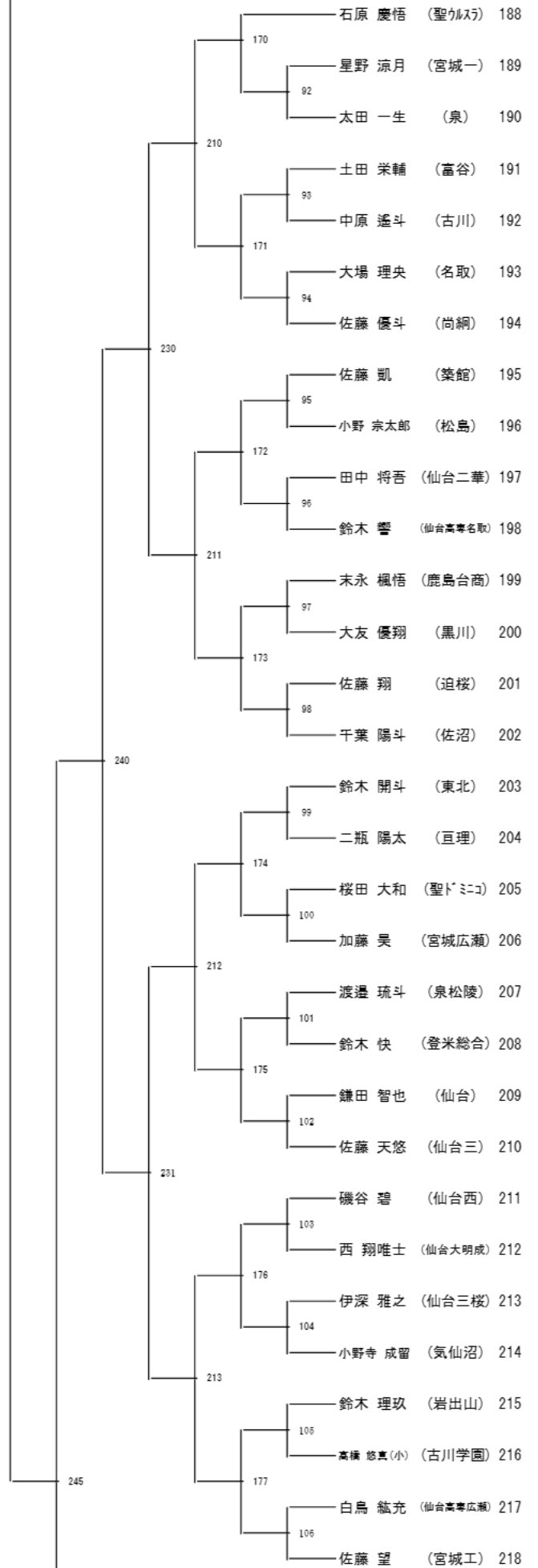
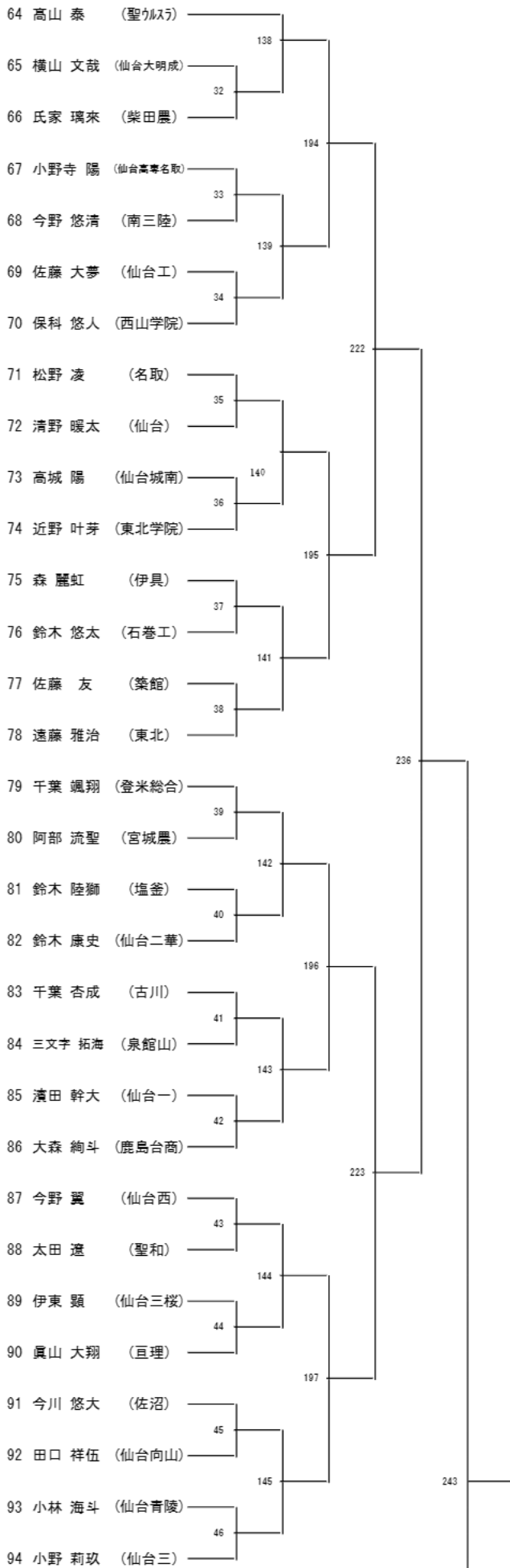

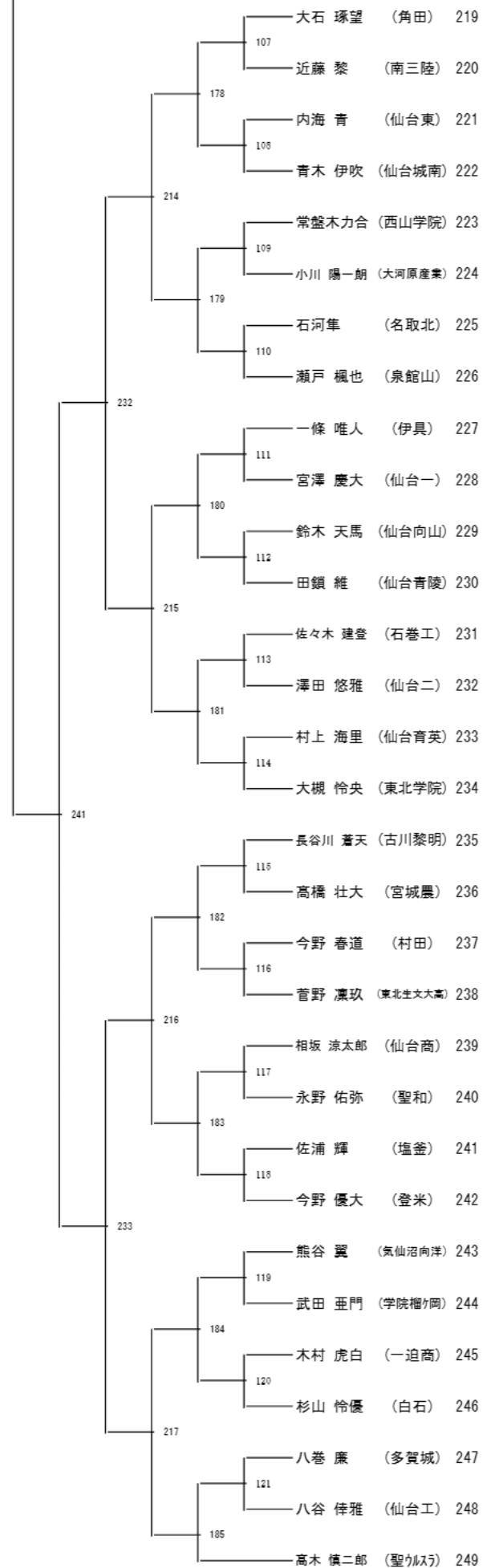
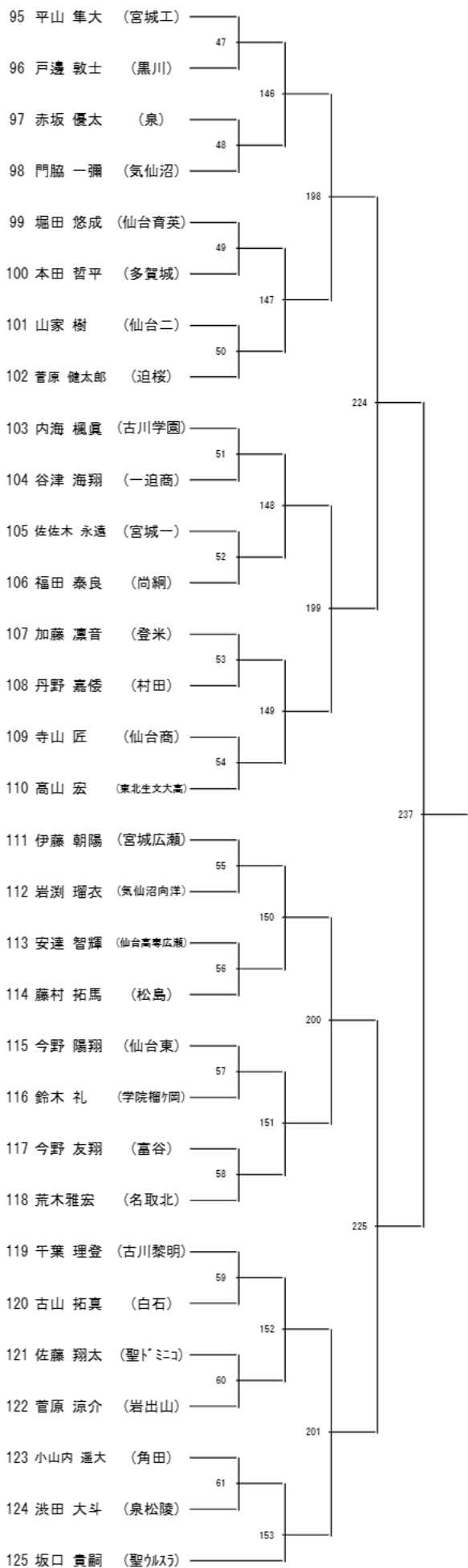

令和6年度 第73回高等学校総合体育大会バドミントン競技 個人対抗戦
 高校女子ダブルス (GD220)

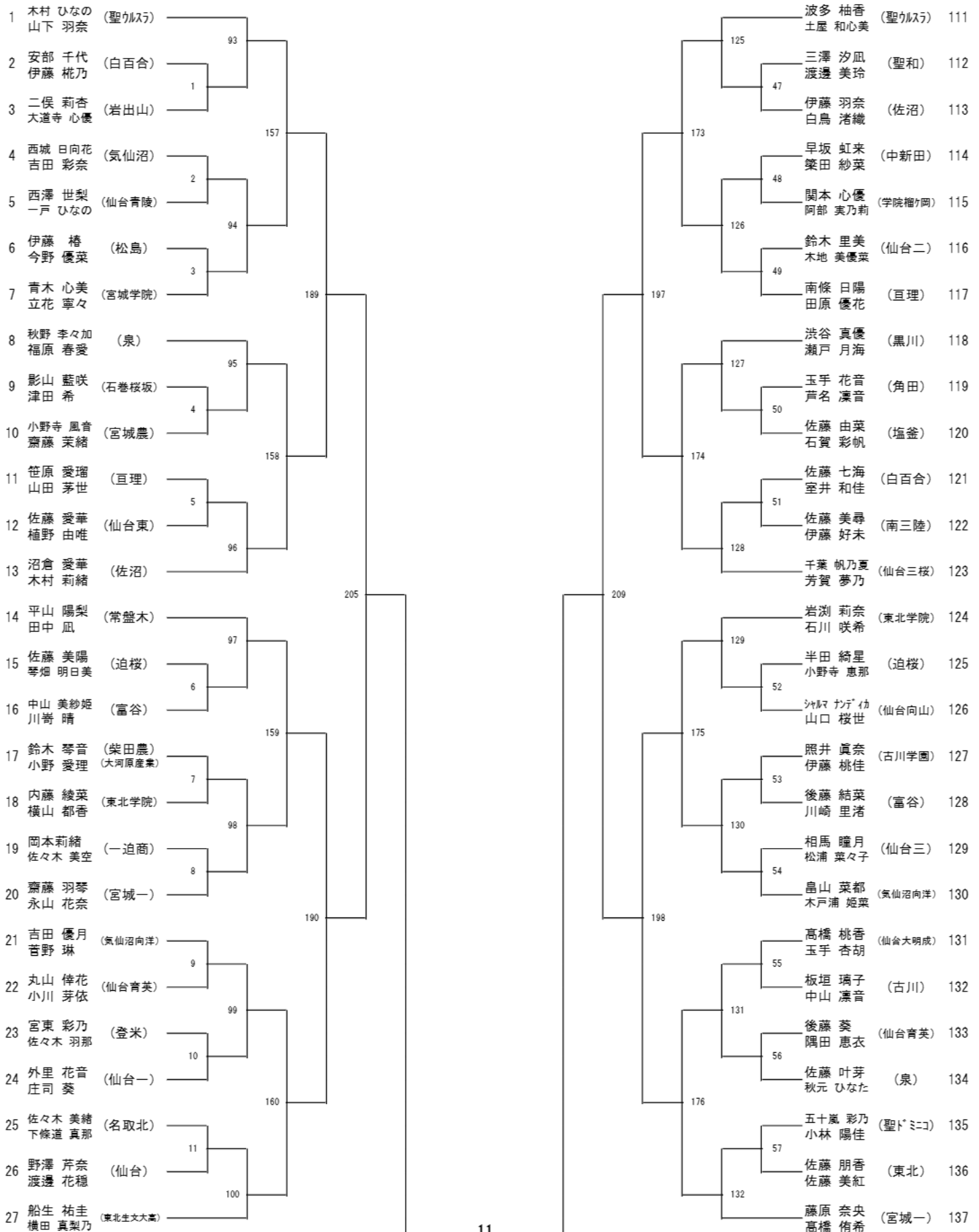

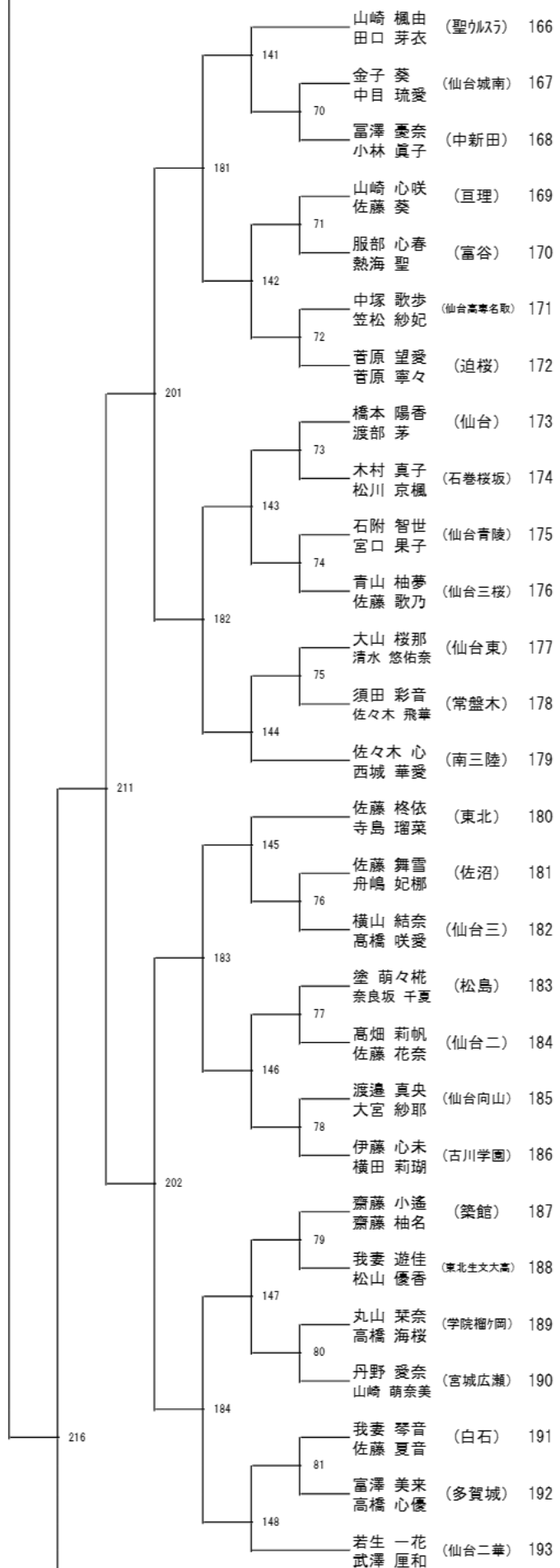
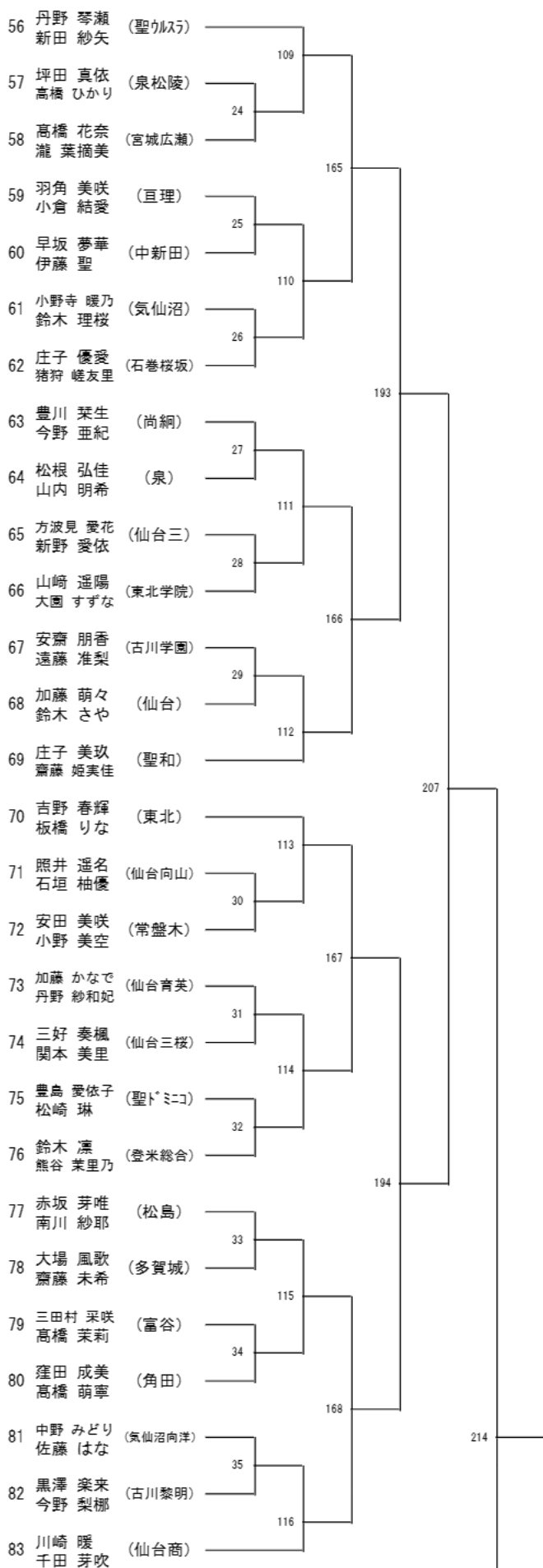

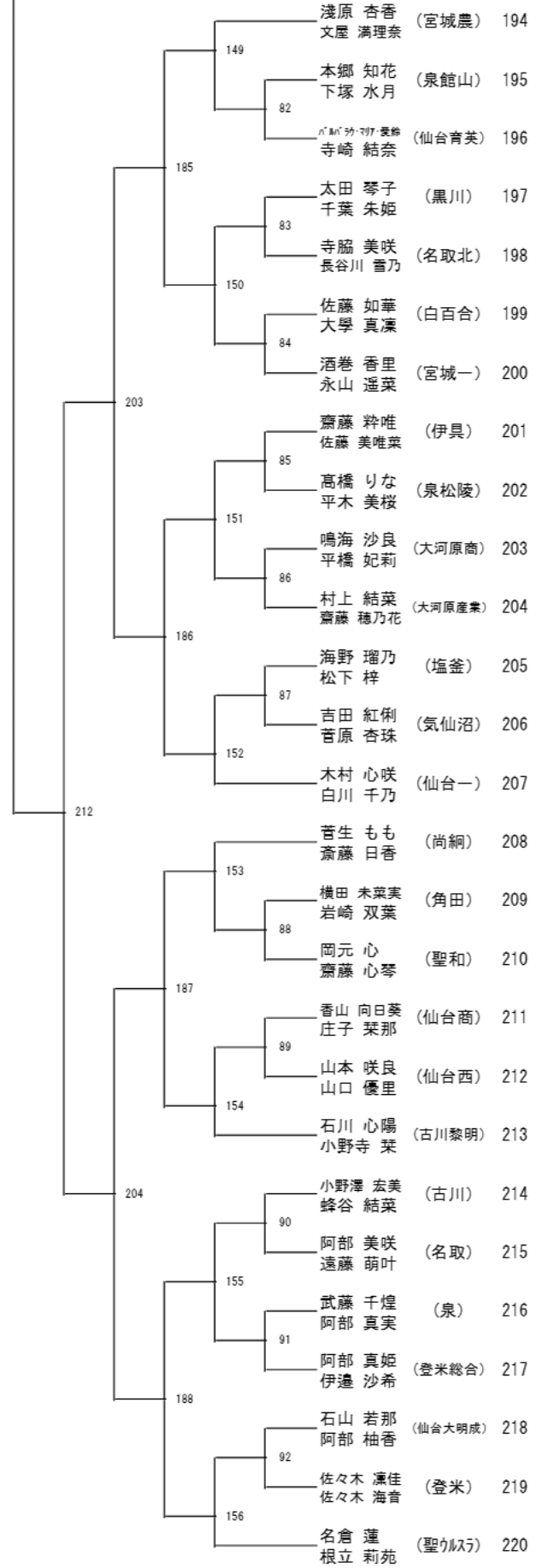
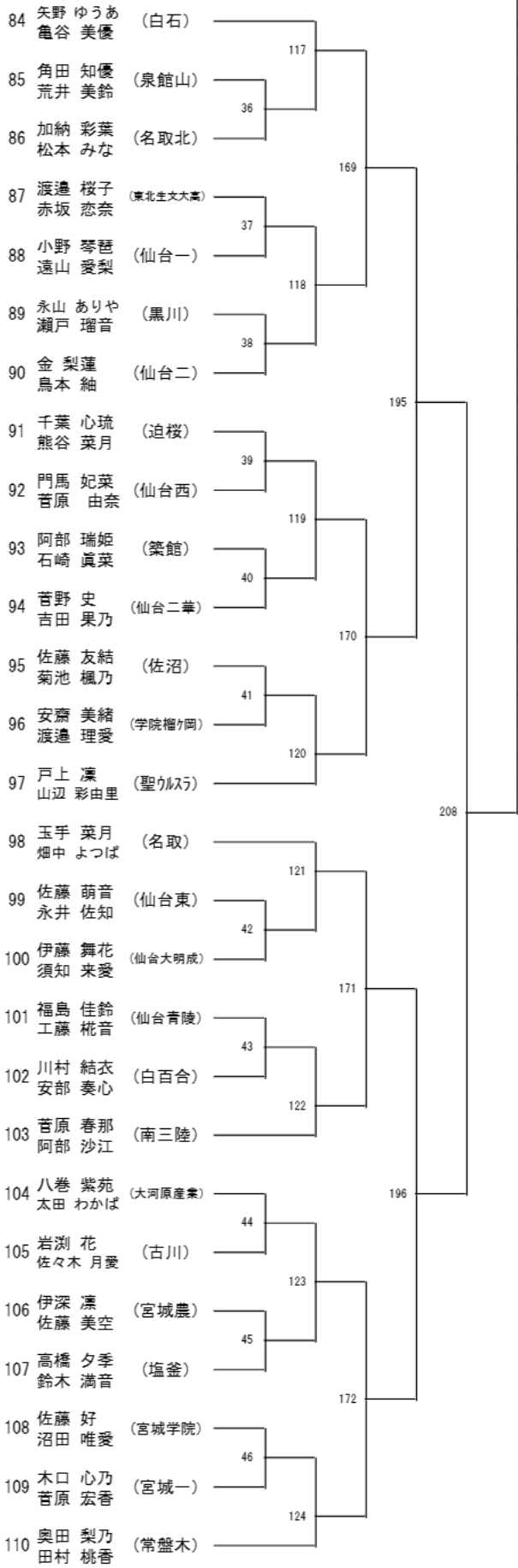

令和6年度 第73回高等学校総合体育大会バドミントン競技 個人対抗戦
女子シングルス (GS248)

